

scala rider®
SMARTPACK



Bluetooth®



DMC™

Dynamic Meshwork
Communication

User Guide

CONTENTS

1. INTRODUCTION	3
2. CHARGING THE BATTERY	5
3. CUSTOMIZATION AND SETTINGS	6
3.1 CARDO COMMUNITY WEB PLATFORM	7
3.2 CARDO SMARTSET APP*	7
3.3 MENU NAVIGATION	7
4. GETTING STARTED	9
4.1 GENERAL FUNCTIONS	9
4.2 STATUS LIGHTS	9
4.3 PARALLEL AUDIO STREAMING AND AUDIO SOURCE PRIORITIES	10
4.4 VOICE COMMANDS	10
4.5 VOICE CONNECT (VOX)	12
5. INTERCOM	13
5.1 DMC INTERCOM MODE	14
5.2 BLUETOOTH INTERCOM MODE	17
5.3 BUSY SIGNAL	24
5.4 RECEIVING INTERCOM CALLS	24
6. USING A MOBILE PHONE, GPS OR MP3 PLAYER	25
6.1 PAIRING BLUETOOTH CHANNELS 1 AND 2	25
6.2 MAKING AND RECEIVING PHONE CALLS	26
6.3 LISTENING TO MUSIC VIA A2DP	27
6.4 MUSIC SHARING	27
7. FM RADIO	28
7.1 RADIO TUNING	28
7.2 AUTOMATIC RADIO TUNING	29
8. TROUBLESHOOTING	29
9. SUPPORT	29

IMPORTANT:

This is version 1.0 of the User Manual. Please note, that the manual is periodically updated on the Cardo website to include the very latest features and functions.

Please visit cardosystems.com/product-manuals to check if the manual you are holding is the most updated version and to download the manual in your preferred language.

scala rider

SMARTPACK

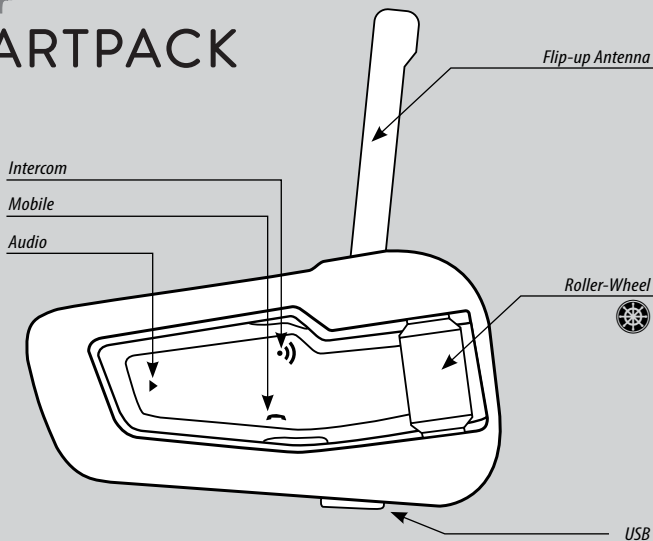

scala rider SMARTPACK button layout

1. INTRODUCTION

Thank you for choosing the scala rider SMARTPACK™ communication and entertainment system for motorcycle helmets.

If you have purchased the SMARTPACK DUO, your retail box contains two factory-paired units.

The scala rider SMARTPACK offers the following key features:

INTERCOM OPTIONS

Dual DMC™ (Dynamic Meshwork Communication) and Bluetooth® intercom technologies on board - with a range of up to 1 mile / 1.6 km* bike-to-bike in full duplex.

DMC Intercom Mode:

- For groups of up to 4 riders over a dynamic auto-adaptive mesh
- Seamless group communication - each rider connects independently
- Up to 3 miles / 5 km extended intercom range with 4 riders in DMC mode

Bluetooth Intercom Mode:

- “1+8” Toggling with 8 additional buddies
- Conference - Between 2, 3 or 4 riders using Channels “A” and “B”
- *Click-to-Link*®: For spontaneous connection with other CTL-enabled riders nearby

MULTIPLE DEVICE CONNECTIVITY

Dual headset profile to connect 2 devices simultaneously for use with:

- Mobile phones (require *Bluetooth* connection)
- GPS navigation systems (require *Bluetooth* connection)
- MP3 players (wireless via A2DP / AVRCP)

ENTERTAINMENT OPTIONS

- Audio streaming via devices supporting *Bluetooth* Stereo A2DP and AVRCP profiles
- Music Sharing: Rider and Passenger can enjoy the same stereo music (via A2DP)
- Built-in FM Radio with 6 station presets and automatic tuning



CARDO COMMUNITY® and CARDO SMARTSET APP

- Download the latest software upgrades and get new features
- Use your smartphone as a Remote Control on the handlebar
- Easily add and remove paired devices
- Customize your settings

ADVANCED TECHNOLOGY

- Voice Commands for safe and hands-free operation of key functions
- AGC and VOX technologies to automatically adjust speaker volume and microphone sensitivity according to ambient noise and riding speed (Customizable and Pat. Pending)
- Spoken status announcements (multi-lingual)
- Volume Per Mode: Volume is set and saved at different levels for each audio source

We wish you a great experience with your scala rider SMARTPACK and encourage you to write us at **support@cardosystems.com** with any questions, suggestions or comments you may have.

* Under tough environmental conditions (dense forest, narrow buildings, heavy traffic), intercom range will be reduced. Once conditions improve, the range will increase again.

2. CHARGING THE BATTERY

Make sure that the battery is fully charged for at least 4 hours before initial use.

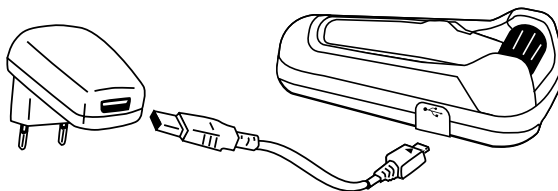

Charging with the wall charger is faster than via a computer USB port.

- RED LED ON – Charging
- RED LED OFF – Charging complete.

Android App users can find a battery indicator in the bottom right-hand corner of the App.

iOS App users can find a *Bluetooth* headset battery indicator icon next to the battery icon on their Apple device.



The scala rider SMARTPACK is waterproof and dustproof. However, when in use, the USB silicone cover should be kept tightly closed to prevent moisture from entering the unit.



3. CUSTOMIZATION AND SETTINGS

Get the most out of your scala rider by changing the settings and customizing your unit according to your own personal preferences.

There are three ways to change the settings: via the *Cardo Community* on a PC / Mac*, the *Cardo SmartSet* App or from the Menu on your device.

	Cardo Community	SmartSet App	Menu
Create, join or leave a pack of riders	✗	✓	✓
Set your Buddy name for 1+8 Intercom	✓	✗	✗
Add friends to your Buddy list	✓	✗	✗
Download the latest firmware upgrade	✓	✗	✗
Set the 6 FM radio presets	✓	✓	✗
Hot-Dial number	✓	✓	✗
Intercom-to-Phone (Enable/Disable)	✓	✓	✗
RDS (Enable/Disable)	✓	✓	✓
Audio priority (A2DP/Intercom)	✓	✓	✓
Parallel Audio Streaming settings (Enable/Disable)	✓	✓	✓
Intercom Mode (DMC/Bluetooth)	✗	✓	✓
Voice Recognition language	✓	✓	✓
Spoken Status Announcements (Enable/Disable)	✓	✓	✓
AGC sensitivity for the speakers (Off/Low/Medium/High)	✓	✓	✓
VOX Operation Mode (Voice Command/Call Intercom)	✓	✓	✓
VOX sensitivity for the microphone (Off/Low/Medium/High)	✓	✓	✓
Click-to-Link settings (Enable/Disable)	✓	✓	✓

3.1 CARDO COMMUNITY WEB PLATFORM

Visit <http://community.cardosystems.com>

Minimum Requirements: Windows® XP™ / Mac OS X 10.7

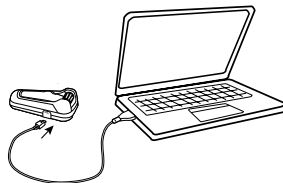

3.2 CARDO SMARTSET APP*

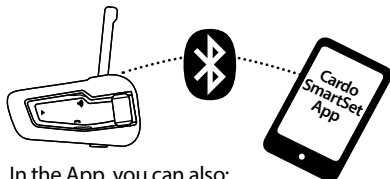

In the App, you can also:

- Add / Remove Intercom pairings
- Make Phone / Intercom calls
- Control your music
- Find / Change radio stations
- Set volume levels for each audio source

Minimum Requirements:

Android: 3.0, iOS: 8.0

* App available only on iOS and Android devices

3.3 MENU NAVIGATION



Use the roller-wheel (🌀) to access and navigate the built-in menus to easily operate and customize your scala rider SMARTPACK.

The menu will vary according to which mode you are in (Standby/A2DP Music/FM).

The Settings menu and Advanced Settings menu can be accessed only in Standby Mode.

Menus are available in several languages.

Enter Menu	Double-tap 🌀
Enter Settings Menu	In Standby, tap 🌀 three times
Select	Tap 🌀 or 🔄
Back / Up	Tap 🔄 (only in Settings menu)
Exit Menu	Press 🔄 for 2 seconds



Settings menu (3 taps on )
A2DP / Intercom audio priority
VOX Operation Mode
Spoken Status Announcements
<i>Click-to-Link</i>
AGC
RDS
VOX
Parallel Audio Streaming
Language

Advanced Features menu in <i>DMC mode</i>
Create a Pack
Join a Pack
Leave the Pack
Pair Mobile Phone to Channel 1
Pair Mobile Phone to Channel 2
Pair GPS to Channel 1
Pair GPS to Channel 2
Reset Mobiles and GPS pairing
Reset to Factory settings

A2DP mode menu
Scan tracks up
Scan tracks down
Start / Stop Music Sharing <i>(only in BT Intercom mode)</i>







Standby mode menu
Mute / Unmute the Pack <i>(only in DMC mode)</i>
Play Music
Play Radio
Start Intercom <i>(only in Bluetooth mode)</i>
Voice Dial
Redial
Hotdial
Switch Intercom mode <i>(DMC/Bluetooth)</i>
Advanced Features Menu

Advanced Features menu in <i>Bluetooth mode</i>
Pair Intercom Channel A
Pair Intercom Channel B
Pair Mobile Phone to Channel 1
Pair Mobile Phone to Channel 2
Pair GPS to Channel 1
Pair GPS to Channel 2
Cardo Gateway on Intercom Channel B
Reset Mobiles and GPS pairing
Reset Channel A & B pairing
Reset 1+8 Buddy pairings
Reset to Factory settings

FM Radio mode menu
Auto Scan 6 stations
Seek stations up
Scan stations up
Scan stations down

4. GETTING STARTED

4.1 GENERAL FUNCTIONS

Power ON	Press  for 2 seconds 3 BLUE flashes + ascending tone
Power OFF	In Standby, press  for 2 seconds 3 RED flashes + descending tone
Volume	Roll the  forward or backward to adjust and set volume of current audio source
Mute	Roll the  backward and then forward very fast
Enable / Disable VOX <i>(For Intercom / Voice Commands only)</i>	In Standby, tap  and  simultaneously <ul style="list-style-type: none"> • Enabled: Blue flash for 2 seconds • Disabled: Red flash for 2 seconds

4.2 STATUS LIGHTS

None	OFF
1 BLUE flash every 3 seconds	Standby in Bluetooth mode – No active audio
1 GREEN flash every 3 seconds	Standby in DMC mode – No active audio
1 RED flash every 3 seconds	Standby – Battery is low
2 BLUE flashes every 3 seconds	Active audio in Bluetooth mode Call in progress / music or other audio source is ON
2 GREEN flashes every 3 seconds	Active audio in DMC mode Call in progress / music or other audio source is ON
2 RED flashes every 3 seconds	Active audio – Battery is low
Solid RED	Charging / USB connected
Solid YELLOW for 2 secs	Pairing unsuccessful, pack is full

4.3 PARALLEL AUDIO STREAMING AND AUDIO SOURCE PRIORITIES

The scala rider SMARTPACK can stream audio from two connected sources simultaneously, so that you can listen to your music or the radio while holding an intercom conversation. Parallel Audio Streaming is automatically disabled during mobile phone conversations.

By default, Parallel Audio Streaming is enabled. See section 3 to adjust the settings. If disabled, the scala rider will automatically determine which audio source to play based on the priority of the connected devices.

<p>Higher Priority</p>  <p>Lower Priority</p>	<ol style="list-style-type: none"> 1. Mobile Phone or GPS instructions* 2. Intercom (DMC and Bluetooth modes) 3. A2DP (Stereo Bluetooth) audio 4. FM Radio (Built-in) <p style="text-align: right; font-size: small;"><i>*GPS instructions from Smartphone GPS Apps are prioritized like A2DP audio</i></p>
---	---

A2DP audio priority can be configured to be higher than Intercom. See section 3 to adjust settings.

- Incoming **mobile phone calls** interrupt ongoing **intercom calls**
- Incoming **intercom calls** will interrupt **FM radio**
- Intercom modes all have the same priority - ongoing intercom calls will not be interrupted by any other intercom call

4.4 VOICE COMMANDS

The Voice Commands allow you to perform certain actions by simply using your voice. Using advanced Voice Recognition, you can control the SMARTPACK completely handsfree.

The default Voice Command language is English. Other languages are also available - see section 3 to adjust settings.

Throughout this manual, features which are available via Voice Command are marked with the  icon.

1. With no call in progress, tap  or speak any word loudly to activate VOX
2. Speak a Voice Command from the table:

Current Mode	Desired Action	Say this:
Standby	Hear Voice Command List	“Command List”
	Start A2DP	“Music ON”
	Turn on FM	“Radio ON”
	Battery Status	“Battery Status”
Standby / FM / A2DP	“1+8” Intercom Call	<<Say Buddy Name>> *
	Intercom call with A and B	“Call Intercom” *
FM Radio	Turn off FM	“Radio OFF”
	Next Station Preset	“Next Station”
	Previous Station Preset	“Previous Station”
A2DP Music	Stop / Pause A2DP	“Music OFF”
	Next Track	“Next Track”
	Previous Track	“Previous Track”
DMC Intercom	Mute the Pack	“Mute the Pack”
	Unmute the Pack	“Unmute the Pack”

*only in Bluetooth Intercom mode



Voice Recognition performance may vary based on environmental conditions including driving speed, helmet type and ambient noise.

For improved performance of the Voice Command feature, minimize wind impact on the microphone by using the large microphone sponge and closing the visor.



4.5 VOICE CONNECT (VOX)

The SMARTPACK has VOX technology for safe and hands-free operation of some key functions. See section 3 to adjust VOX settings.

VOX Activation	Speak any word loudly into the microphone
Answer a call	Speak any word loudly into the microphone
Reject a call	Remain silent for about 15 seconds
VOX Sensitivity (Default: Medium)	High: Use this setting if it is difficult to activate VOX Low: Use this setting if it is too easy to activate VOX
VOX Operation Mode	Set VOX to either activate the Voice Command (default) or to start an Intercom Call.
Enable/Disable VOX (For Intercom/Voice Commands only)	In Standby, tap  and  simultaneously • Enable: Blue flash for 2 seconds • Disable: Red flash for 2 seconds

5. INTERCOM

The scala rider SMARTPACK communication and entertainment system contains TWO intercom technologies that work to complement each other.

DMC™ intercom mode enables groups of riders to communicate via intercom independently of each other, seamlessly and automatically adapting to rapid changes of the group. DMC is currently available exclusively on scala rider PACKTALK and SMARTPACK models.

The SMARTPACK is limited to a maximum of 4 people in DMC intercom mode.

Bluetooth intercom mode is compatible with other *scala rider* intercom models, the *cardo SHO-1* and Schuberth's *SRC-System™*. Non-Cardo devices can connect via the Cardo Gateway, allowing conversation between your SMARTPACK and a non-Cardo brand of *Bluetooth* intercom.

All intercom communication is full duplex with a range of up to 1 mile / 1.6 km (subject to terrain and within line of sight). In DMC mode, intercom range can be extended to up to 3 miles / 5 km with groups of 4 riders.

Intercom range with other models is limited to the distance of the device with the shorter range.

For more info please visit www.cardosystems.com/SMARTPACKcompatibility

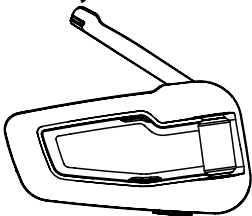



Open the antenna for maximum range

To talk to someone via Intercom, first pair your scala rider SMARTPACK to the second unit. Pairing is a one-time process. Once paired, the units should automatically recognize each other whenever in range.



5.1 DMC INTERCOM MODE

The default intercom mode is *Bluetooth* Intercom. To switch to *DMC* intercom mode:

- Use the *Cardo SmartSet* App (see section 3.2)
- or enter the Standby menu and choose 'Switch Intercom mode'
- or in Standby mode, tap  and  simultaneously

Introduction

The scala rider SMARTPACK uses *DMC* technology to create a spontaneous and fluid virtual network of riders. *DMC* provides a more stable connection in a group of riders than the *Bluetooth* intercom mode.



In *DMC* intercom mode, each rider acts as an autonomous hub that maintains simultaneous and independent communication links with each of the other members in the pack, operating in a mesh network.

Members may join, leave and rejoin the pack conversation without compromising the integrity of the ongoing multi-point conference call among the other pack members.

Whenever a SMARTPACK user cannot directly connect with pack members beyond his intercom reach, it will re-adjust within split seconds and re-connect to the most suitable other pack member in order to 'leapfrog' to the remote member.

Create a new pack

The easiest way to create a new pack is via the *Cardo SmartSet* App, or from the Advanced Features Menu in Standby mode.

Alternatively, in *DMC* mode, press  for 5 seconds to enter intercom grouping mode. While the LED is flashing, tap  to define yourself as the "Pack Creator". Your unit will then proceed to search for pack members in *DMC* intercom grouping mode and automatically add them to your pack. If no units are found within 2 minutes, your unit will return to Standby mode.

The SMARTPACK is limited to a maximum of 4 people in DMC intercom mode.

A pack can only have one "Pack Creator". The pack can still continue to function even if the Pack Creator is no longer available.

Join an existing pack

The easiest way to join a pack is via the *Cardo SmartSet* App, while the Pack Creator is nearby and in DMC pairing mode. The process can also be done from the Advanced Features Menu in Standby mode.



Alternatively, make sure your unit is in *DMC* intercom mode and that you are within 3 m / 10 ft. from the Pack Creator. While the Pack Creator is in Grouping mode, press  for 5 seconds on your unit.

A Purple LED indicates that grouping with the Pack Creator has been successful.
A Yellow LED indicates that the pack is full and no additional members can join.

Using DMC intercom

With the SMARTPACK, up to 4 riders can participate in a pack, with all pack members able to speak and hear everyone else. Once you are in a pack, you can start talking to other members of your pack instantly.

Mute the pack

If for any reason you would like to mute the conversation but still remain a pack member, press  for 2 seconds. Tap  to rejoin the conversation.







Leaving a pack

If your connection is lost for any reason, you will remain a member of the pack until your SMARTPACK unit can reconnect to any of the other members of the pack. If you choose to leave the pack you can:

- Use the *Cardo SmartSet* App.
- Choose 'Leave the Pack' in the Advanced Features Menu in Standby mode
- Join a new pack

Rejoining a pack

If you have joined a different pack or chosen to leave a pack, and later wish to rejoin the original pack, simply pair your unit with the Pack Creator again. If the Pack Creator is no longer available, a new pack should be created and all members should pair again to the new Pack Creator.

Create a pack	<p>Via the <i>Cardo SmartSet</i> App, the Advanced Features Menu, or: In DMC mode, press  for 5 seconds to enter intercom pairing mode. While the LED is flashing, tap  to define yourself as the Pack Creator.</p>
Join a pack	<p>Via the <i>Cardo SmartSet</i> App, the Advanced Features Menu, or: While the Pack Creator is in Pairing mode, press  for 5 seconds on your unit. PURPLE LED: Success YELLOW LED: Pack is already full</p>
Mute / Unmute the pack 	<p>Press  for 2 seconds</p>
Leave a pack	<p>Via the <i>Cardo SmartSet</i> App or the Advanced Features Menu</p>
Switch Intercom mode	<p>Via the Standby Menu, the <i>Cardo SmartSet</i> App or: In Standby, tap  and  simultaneously.</p> <ul style="list-style-type: none"> • Bluetooth: Blue LED • DMC: Green LED

5.2 BLUETOOTH INTERCOM MODE

Bluetooth Intercom communication is possible using one of the three methods:



Section 5.2a	"1+8" Toggling (between scala rider SMARTPACK / PACKTALK, G9/G9x and cardo SHO-1 / SRCS PRO models)	2-way Intercom conversations within a group of up to eight other "1+8" Buddies
Section 5.2b	Conference via Channels A/B (with any Cardo or other brand of intercom model)	Intercom Conferencing (2-way, 3-way and 4-way) using Channels "A" and "B"
Section 5.2c	Click-to-Link (with any CTL-compatible model)	1-on-1 spontaneous intercom conversations with random riders near you who are not already paired to your SMARTPACK



5.2a “1+8” INTERCOM TOGGLING

(with SMARTPACK, PACKTALK, G9 / G9X, cardo SHO-1 and SRCS PRO)

Pair with up to 8 other devices (“1+8” Buddies) and connect with them one at a time by saying their name.

CONFIGURE YOUR BUDDY NAME

Before using “1+8” Intercom, you should assign yourself a Buddy name, so that other paired Buddies can call you by this name. Visit the *Cardo Community* to configure your Buddy Name (see Section 3).

Until you configure a Buddy name, your unit will be known as “SMARTPACK”.

If you change your Buddy name, you must pair again with your “1+8” Buddies for their devices to receive the new name.

Hear Your Buddy Name	In Standby, press and simultaneously for 2 seconds. You will hear your Buddy name through the speakers.
Check Your Buddy List	Check via the <i>Cardo SmartSet</i> and <i>Cardo Community</i> . You can also hear your Buddy List through the speakers: In Standby, press for 2 seconds

PAIRING “1+8” BUDDIES

There are three ways to pair with “1+8” Buddies:



OPTION 1: Via the *Cardo Community*® (ALL models)



OPTION 2: Via the *Cardo SmartSet App* (PACKTALK/SMARTPACK models)



OPTION 3: Manual “1+8” Pairing (PACKTALK/SMARTPACK models)

1. In Standby, press for 5 seconds to enter “1+8” Pairing mode.
2. Enter “1+8” Pairing mode on the second unit.
3. A purple LED for 2 seconds indicates *pairing* was successful.

If your scala rider already has a full list of 8 paired “1+8” Buddies, pairing another buddy will replace the buddy that you have not spoken to for the longest time.





CALLING “1+8” BUDDIES

There are three ways to start an intercom call with “1+8” buddies.

OPTION 1: Voice Command (VOX)

Say any word loudly into the microphone. When you hear the Voice Command tone, say the name of a “1+8” Buddy i.e. “John Smith”. VOX Operation settings must be set to “Voice Command” (see section 3).

OPTION 2: Manual Mode

SAY THE NAME	CHOOSE THE NAME (from your Buddy List):
Tap  and say the Buddy name	In Standby, press  for 2 seconds to hear your Buddy List. When you hear the name of the Buddy you wish to call, tap  or say any word loudly into the microphone. To cancel Buddy List playback: Press  for 2 seconds.



OPTION 3: Via the *Cardo SmartSet App*

INTERCOM-TO-PHONE

In *Bluetooth* Intercom mode, if a “1+8” Buddy is not in range, or moves out of range, you have the option to set up the “Intercom-to-Phone” feature via the *Cardo Community* or *Cardo SmartSet App*, to remain in contact by diverting Intercom calls automatically to your mobile phones.



5.2b INTERCOM WITH CHANNELS “A” AND “B”

Start multi-party conversations using Intercom Channels “A” and “B”. This mode is suitable for 2, 3 or 4-way calls.

PAIRING INTERCOM CHANNELS “A” AND “B”

Pairing a channel will replace any existing paired device on that Channel with the newly paired device.

If you have purchased the SMARTPACK DUO, both units are factory-paired and configured to communicate via Channel “A”. If for any reason you have to pair them again, OR if you wish to pair a different unit to make Intercom calls, proceed as follows:

There are three ways to pair Intercom (IC) Channels “A” and “B”:



OPTION 1: Via the *Cardo SmartSet App*





OPTION 2: Advanced Features Menu

1. Make sure your unit is in *Bluetooth* Intercom mode and in Standby.
2. Double-tap  and choose the Advanced Features Menu (see 3.3).
3. Select either “Pair Intercom Channel A” or “Pair Intercom Channel B”.



OPTION 3: Manual Pairing

1. Check that all units are in Standby.
2. **To pair IC Channel A** – press  for 5 sec. until the RED LED begins flashing rapidly.
To pair IC Channel B – press  for 5 sec. until the RED LED begins flashing rapidly.
Then double-tap . A flashing BLUE LED indicates Channel “B” pairing mode.
3. Enter IC Pairing mode on the second unit following its user manual. Both units will now be in Intercom Pairing mode.
4. After a few seconds, both units will show a solid LED for 2 seconds, indicating that they are paired and ready to use.
5. If Pairing is not completed within 2 minutes, the units will return to Standby.



CARDO GATEWAY

Non-Cardo devices can connect via the “Cardo Gateway”, allowing conversation between your SMARTPACK and a non-Cardo brand of Bluetooth intercom.

Cardo Gateway pairing is done on Intercom Channel “B”.

There are three ways to pair with a non-Cardo brand of Bluetooth intercom:



OPTION 1: Via the *Cardo SmartSet* App



OPTION 2: Advanced Features Menu

Enter the Advanced Features Menu (see 3.3) and select “Cardo Gateway” to enter pairing mode on the scala rider.



OPTION 3: Manual Pairing

Enter Intercom Channel “B” pairing mode (see above) and tap .

Next, enter Mobile Phone Pairing mode on the second unit following its user manual. After a few seconds, a solid LED will appear for 2 seconds, indicating that the two units are paired.

If Pairing is not completed within 2 minutes, the unit will return to Standby mode.

CALLING INTERCOM CHANNELS “A” AND “B”

OPTION 1: Voice Connect (VOX)

Say any word loudly into the microphone. When you hear the Voice Command tone, say “Call Intercom” to start an intercom call with “A” and/or “B” (subject to who is present).



VOX Intercom calls with only “A” or “B” will end automatically after 30 seconds of silence.





OPTION 2: Via the *Cardo SmartSet* App

OPTION 3: Manual Mode

Use this to start an Intercom call with either:

- Channel “A”: Tap 
- Channel “B”: Double tap 

To end a call with either Channel “A” or “B” - tap 

To end a conference call with both “A” and “B” - Press  for 2 seconds.

If you are already in an Intercom call with “A” or “B”, you can add another rider (“A” or “B”) by double-tapping .

THREE-WAY INTERCOM

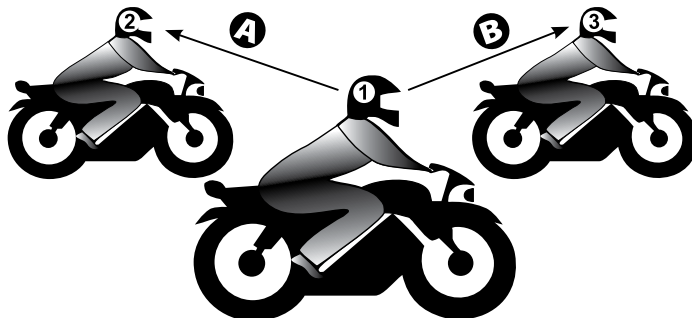

FOUR-WAY INTERCOM

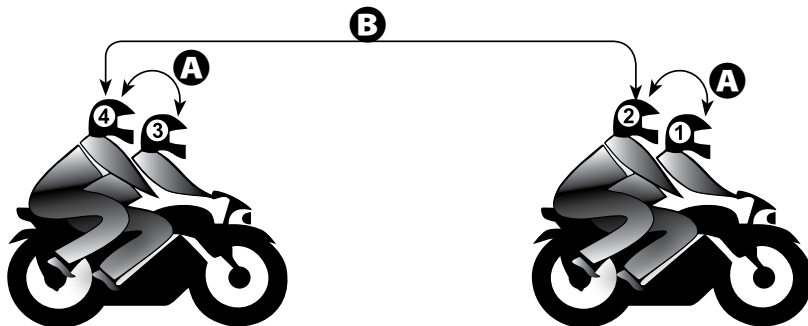

IMPORTANT: Conference Mode Considerations

During a 3 or 4-Way Intercom Conference call, riders using both intercom channels "A" and "B" will not be able to receive phone calls or GPS instructions as long as the call is in progress.



5.2c CLICK-TO-LINK (CTL) INTERCOM MODE



Click-to-Link is a spontaneous way to instantly initiate 1-on-1 intercom calls with other riders near you, without being paired. Think of it as a private channel that you can set up on-the-go with other riders that you see along the way.

Click-to-Link can be disabled effectively blocking any attempt by a third party to send a CTL request to you.

Start a CTL call request (search lasts up to 10 sec.)	In Standby, press for 2 seconds
End a CTL call / Cancel a CTL call request	Tap
Accept a CTL call	When hearing the CTL ringtone: Tap or say any word loudly to answer by VOX
Reject a CTL call	While hearing the CTL ringtone, remain silent until the ring tone stops, or press for 2 seconds
Enable / Disable CTL (Enabled by default)	See section 3

If other riders are nearby, your next *Click-to-Link* call may randomly connect to any of them.

5.3 BUSY SIGNAL

When attempting to establish an Intercom call with another device that is already busy, a “busy” signal will be heard. The scala rider is busy while on a phone call, intercom call with Channels “A” **and** “B”, “1+8” intercom call or CTL call.

5.4 RECEIVING INTERCOM CALLS

If a paired unit tries calling you via Intercom, the call will begin almost instantly.

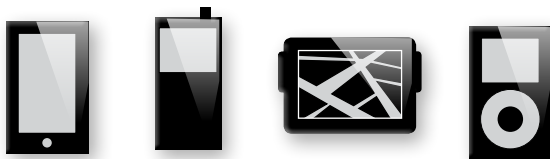

6. USING A MOBILE PHONE, GPS OR MP3 PLAYER



To use a *Bluetooth* device with your scala rider SMARTPACK you must first pair them. Once paired, they will automatically recognize each other whenever they are within range (10m / 33ft).

Your scala rider has two *Bluetooth* channels to connect mobile phones, GPS devices and music players with A2DP.

6.1 PAIRING *BLUETOOTH* CHANNELS 1 AND 2











1. Make sure *Bluetooth* is enabled on your phone/GPS/MP3 player.
2. **To pair *Bluetooth* Channel 1** – In Standby, press  for 5 seconds until the RED and BLUE LEDs begin rapidly alternating.
- To pair *Bluetooth* Channel 2** – In Standby, press  for 5 seconds until the RED and BLUE LEDs begin rapidly alternating.

To pair a GPS, when LEDs begin rapidly alternating, roll the  either forward or back.

3. Search for *Bluetooth* devices on your phone/GPS/MP3 player by following the device's instructions.
4. After a few seconds the device will list your name or "SMARTPACK". Select it.
5. If prompted for a PIN or Passkey, enter 0000 (four zeros).
6. The device will confirm that pairing has succeeded and your unit will return to Standby mode, LED flashing once every 3 seconds.
7. If pairing is not completed within 2 minutes, the unit will return to Standby mode.

- If you have paired 2 different mobile phones directly to your scala rider, you will need to set one as default for making calls.
- If your GPS supports it, you can pair the second mobile phone directly to the GPS and then pair the GPS to your scala rider, and so connect both mobile phones and the GPS to your scala rider.
- Not all Bluetooth mobile phones broadcast Bluetooth Stereo music (A2DP), even if the phone has an MP3 player function. Consult your mobile phone's User Manual for more information.
- Not all Bluetooth GPS devices allow connection to Bluetooth audio devices. Consult your GPS User Manual for more information.
- After pairing, you may need to tap  to connect.

6.2 MAKING AND RECEIVING PHONE CALLS

Answer a call	Tap  or speak any word loudly to answer by VOX
Reject a call	Remain silent for 15 seconds, or press  for 2 seconds
End a call	Tap 
Voice Dial¹ (if supported by mobile phone)	Tap  or use the Feature Menu
Redial¹	Double-tap  or use the Standby Feature Menu
Hot Dial²	Tap  three times or use the Standby Feature Menu
Set default mobile³	While on a phone call, press  for 5 seconds
Change default mobile	In Standby, press  for 2 seconds
INTERCOM CONFERENCE MODE	
Add/Remove Channel "A" to/from a call	Tap  while on a phone call
Add/Remove Channel "B" to / from a call	Double-tap  while on a phone call

¹ This feature is not available during intercom or mobile calls

² Configure a Hot-Dial number via the *Cardo Community* or *Cardo SmartSet App*

³ If 2 mobile phones are paired directly, you need to set one as default for outgoing calls

6.3 LISTENING TO MUSIC VIA A2DP (on A2DP/AVRCP compatible *Bluetooth* audio devices)

Play	In standby, tap or use the Voice Command / Feature Menu
Pause/Stop	Press for 2 seconds or use Voice Command
Next Track	With music ON, tap or use Voice Command
Previous Track*	With music ON, double-tap or use Voice Command
Music Scan	With music ON, tap and roll forward (scans up) or back (scans down). The first few seconds of each audio track will be played.
Stop Scan	To stop the scan on the current track, say any word loudly into the microphone or tap

*With some phones you may need to repeat this action

SWITCHING BETWEEN A2DP AUDIO SOURCES

If two A2DP audio sources are paired, the scala rider will use the default A2DP audio source. To switch to the other audio source, stop the music playback from the current device and start music playback on the other device. Your scala rider will automatically remember your last played device.

6.4 MUSIC SHARING



Music Sharing allows rider and passenger to listen to the same music within a range of 33 ft / 10m.

Music Sharing works only in *Bluetooth Intercom* mode and with A2DP (*Bluetooth* stereo) enabled audio sources. To share your music with your riding partner, your scala rider [SENDER] needs to be paired to the other unit [RECEIVER] on CHANNEL A and the RECEIVER must be in Standby mode.

[SENDER] Start/Stop sharing your music	During A2DP music playback, press for 2 seconds
[RECEIVER] Stop music sharing	Press for 2 seconds

Phone/Intercom calls and GPS audio navigation will override music playback.









Music Sharing does not transmit voice audio and cannot be used as an Intercom call.

7. FM RADIO



Your scala rider includes a built-in FM radio with a 6 Preset memory and RDS (Radio Data System).

RDS allows the radio to automatically retune to the strongest frequency available for the FM station you are listening to when the signal becomes too weak.







Radio On		In standby, double-tap  or use Voice Command or the Standby Feature Menu
Radio Off		Press  for 2 seconds or use Voice Command
Next Station		With radio on, tap  or use Voice Command
Previous Station		With radio on, double-tap  or use Voice Command
RDS ON/OFF (Default: Off)		See section 3 to adjust the settings

7.1 RADIO TUNING

Preset stations can easily be set via the *Cardo Community* and the *Cardo Smartset App*.

You can also save preset stations directly on your scala rider:

1. With the radio on, select a Preset number you wish to set (Preset 1 – 6) by tapping  until the desired preset is heard.
2. Find an FM station to save using Seek or Scan.







Seek a Station (Find the next station)	Choose a preset by tapping  Press  for 5 seconds to seek a radio station Tap  within 20 seconds to save to current preset
Scan stations (Automatically scans for stations)	With radio on, tap  and then roll either forward or backward to start scan To stop scan, tap  Tap  within 20 seconds to save to current preset To continue scan, wait for the next station to be found.

7.2 AUTOMATIC RADIO TUNING

Find 6 temporary radio stations. These stations cannot be saved and do not replace your saved FM Presets. Turning off your unit will clear the temporary stations and restore the FM Presets.

1. With the radio on, tap  three times.
2. The radio will search upwards (higher frequency) from the current station and store the next 6 FM stations it discovers.
3. If desired, repeat to store the next 6 FM stations.

8. TROUBLESHOOTING

Reboot	If the unit stops responding, tap  and  . Then press  for 2 seconds.
Reset to Factory Settings (Deletes all paired devices)	In Standby, press  ,  , and  simultaneously for 5 seconds. Alternatively, use the Cardo SmartSet App or in the Advanced Features menu select "Reset to Factory Settings".

9. SUPPORT

For additional information:



www.cardosystems.com



support@cardosystems.com



USA and Canada: 1-800-488-0363

International: +49 89 450 36819

IMPORTANT

MULTINATIONAL COMMERCE COMPANIES AND ONLINE AUCTION WEBSITES ARE NOT AUTHORIZED TO SELL CARDO PRODUCTS AND PURCHASES FROM SUCH SITES ARE AT YOUR OWN RISK. TO RECEIVE WARRANTY OR CUSTOMER SERVICE, YOU MUST SUBMIT ORIGINAL RECEIPTS FROM AUTHORIZED CARDO DEALERS.

PRODUCTS THAT WERE IMPORTED FROM NORTH AMERICA MUST BE SERVICED IN THE USA.